

# Data Sheet



Article number: 021500700059

Description: Sealing Clamp S 59 W5

## Measures

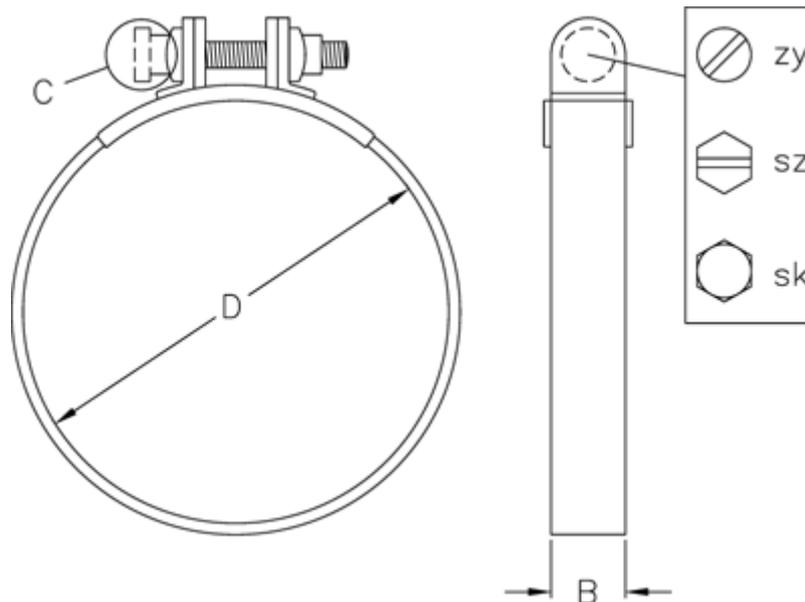

C (screw type) = SZ

Diameter D = 59

Width B = 20